



Non lubrication

Special housing and bushing enables self lubrication of piston rod.

High quality long service life

Hard anodised aluminium cylinder tubes offer a high resistance to corrosion and low internal friction.

Full range of NFPA interchangeable mounting configurations

Mounting dimensions are in accordance with ANSI (NFPA) T3.6.7 R2-1996, fluid power systems and products-square head industrial cylinders-mounting dimensions.

Specification

Model	MCQN				
Tube I.D. (inch)	1 1/2"	2"	2 1/2"	3 1/4"	4"
Tube I.D. (mm)	40	50	63	80	100
Port size	NPTF3/8			NPTF1/2	
Medium	Air				
Max. operating pressure	1 MPa				
Min. operating pressure	0.05 MPa				
Proof pressure	1.5 MPa				
Ambient temperature	- 5~+ 60°C (No freezing)				
Available speed range	50~500 mm/sec				
Sensor switch	RCA				
Sensor switch holder	HV1	HV2		HV3	

Table for standard stroke

Tube I.D.(inch)	Stroke (inch)
φ 1 1/2"	1, 2, 3, 4, 5, 6, 8, 10, 12, 14, 16, 18, 20
φ 2", 2 1/2"	1, 2, 3, 4, 5, 6, 8, 10, 12, 14, 16, 18, 20, 24
φ 3 1/4", 4"	1, 2, 3, 4, 5, 6, 8, 10, 12, 14, 16, 18, 20, 24

※ RCA specification, please refer to page V-05.

Order example

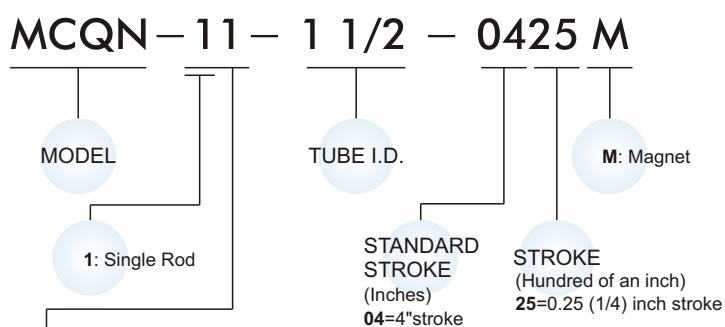

STYLE

Code	Symbol	Description
1 1		Double acting / Male thread







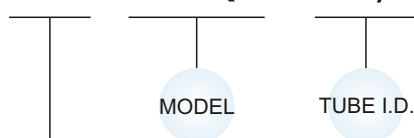

※ Order example for special specification, refer to page J-03.

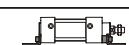
Mounting accessories

FAC - MCQN - 1 1/2

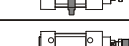

MOUNTING TYPE

	LB
	CB
	CB2
	FAC
	FBC
	TC
	Y
	I

11

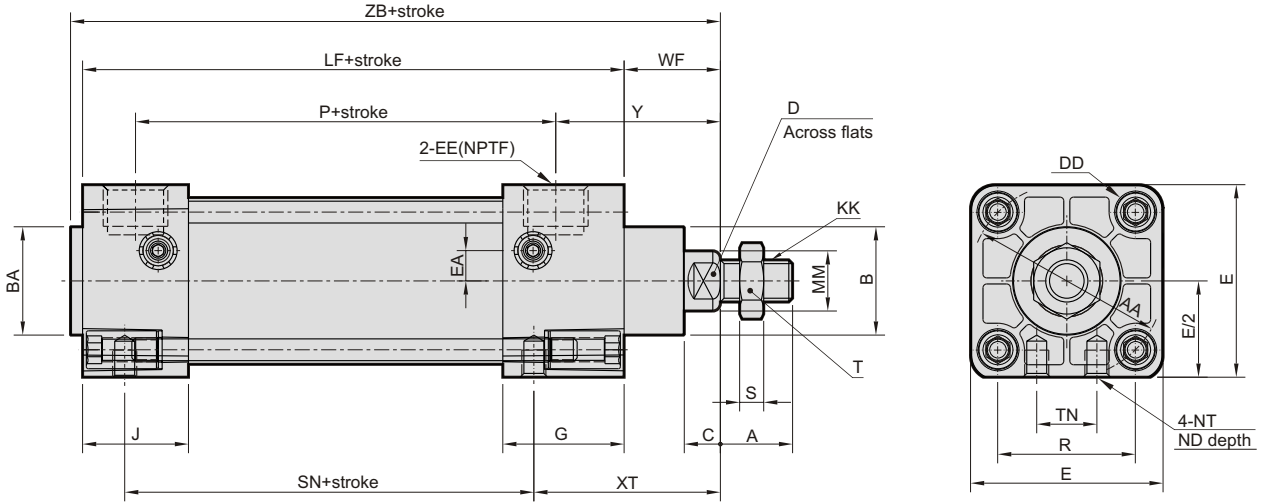

Code Tube I.D.	A	AA	B	BA	C	D	DD	E	EA	EE	G	J	KK	LF	MM	ND	NT	P	R	S	SN
1 1/2"	3/4	2.02	1 1/8	1 1/8	3/8	9/16	1/4-28	2	0.32	3/8	1.26	1.1	7/16-20	3 5/8	5/8	9/32	1/4-20	2.36	1.43	0.26	2 1/4
2"	3/4	2.60	1 1/8	1 1/8	3/8	9/16	5/16-24	2 1/2	0.43	3/8	1.26	1.06	7/16-20	3 5/8	5/8	7/16	5/16-18	2.40	1.84	0.26	2 1/4
2 1/2"	3/4	3.10	1 1/8	1 1/8	3/8	9/16	5/16-24	3	0.47	3/8	1.3	1.06	7/16-20	3 3/4	5/8	19/32	3/8-16	2.48	2.19	0.26	2 3/8
3 1/4"	1 1/8	3.90	1 1/2	1 1/2	1/2	7/8	3/8-24	3 3/4	-	1/2	1.57	1.18	3/4-16	4 1/4	1	5/8	1/2-13	2.72	2.76	0.42	2 5/8
4"	1 1/8	4.70	1 1/2	1 1/2	1/2	7/8	3/8-24	4 1/2	-	1/2	1.57	1.18	3/4-16	4 1/4	1	5/8	1/2-13	2.72	3.32	0.42	2 5/8

Code Tube I.D.	T	TN	WF	XT	Y	ZB
1 1/2"	0.69	0.63	1	1 15/16	1.71	4 3/4
2"	0.69	0.88	1	1 15/16	1.71	4 3/4
2 1/2"	0.69	1.25	1	1 15/16	1.75	4 7/8
3 1/4"	1.12	1.50	1 3/8	2 7/16	2.34	5 53/64
4"	1.12	2.06	1 3/8	2 7/16	2.34	5 53/64

Code Tube I.D.	Sensor switch	Hold	A	B	C	D	E
1 1/2"	RCA	HV1	1.10	1.47	1.02	0.51	M4 × 10L
2"	RCA	HV2	1.49	1.68	1.02	0.51	M4 × 10L
2 1/2"	RCA	HV2	1.66	1.86	1.02	0.51	M4 × 10L
3 1/4"	RCA	HV3	1.87	2.13	1.02	0.51	M4 × 10L
4"	RCA	HV3	2.15	2.42	1.02	0.51	M4 × 10L

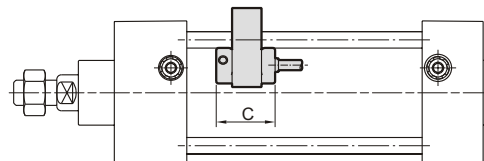
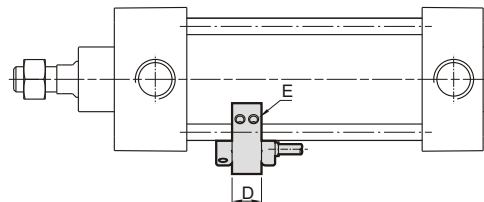
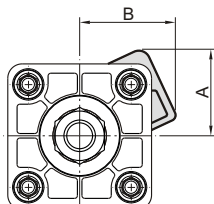
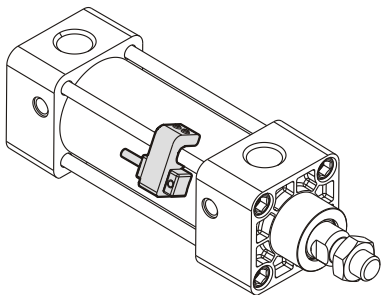

STANDARD CYLINDERS

Mindman

unit: kg

Model	Basic weight MCQN-11	Basic weight (magnet) MCQN-11	Stroke 1 inch MCQN-11
Tube I.D.			
ϕ 1 1/2"	0.664	0.676	0.078
ϕ 2"	0.965	0.981	0.096
ϕ 2 1/2"	1.314	1.334	0.108
ϕ 3 1/4"	2.482	2.510	0.200
ϕ 4"	3.266	3.300	0.220

Model	LB	FAC/FBC	I	PIN	Y	TC	CB	CB2
Tube I.D.								
ϕ 1 1/2"	0.160	0.246	0.150	0.065	0.205	0.554	0.229	0.287
ϕ 2"	0.240	0.403	0.150	0.065	0.205	0.644	0.377	0.424
ϕ 2 1/2"	0.300	0.576	0.150	0.065	0.205	0.840	0.521	0.563
ϕ 3 1/4"	0.633	1.408	0.522	0.175	0.662	1.098	1.302	1.482
ϕ 4"	0.955	2.015	0.522	0.175	0.662	1.450	1.821	2.033

LB

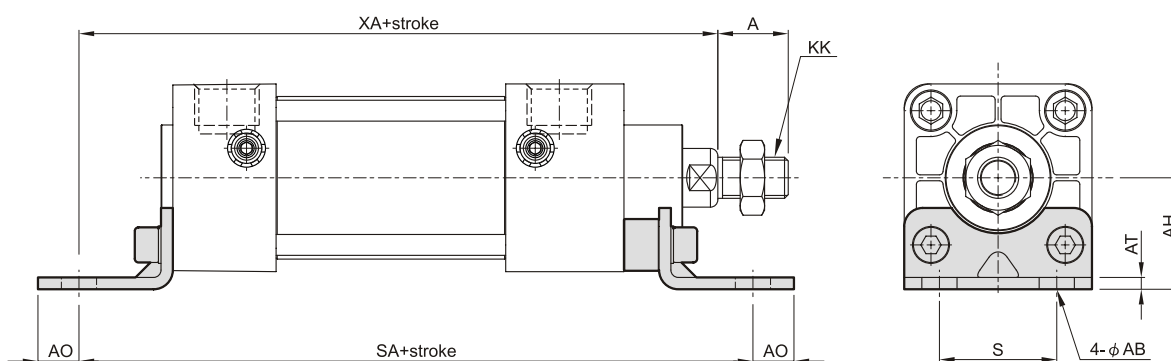

Code Tube I.D.	A	AB	AH	AT	AO	KK	S	SA	XA
1 1/2"	3/4	3/8	1 3/16	1/8	7/16	7/16-20	1 1/4	6	5 5/8
2"	3/4	3/8	1 7/16	1/8	9/16	7/16-20	1 3/4	6	5 5/8
2 1/2"	3/4	3/8	1 5/8	1/8	9/16	7/16-20	2 1/4	6 1/8	5 3/4
3 1/4"	1 1/8	1/2	1 15/16	11/64	3/4	3/4-16	2 3/4	7 3/8	6 7/8
4"	1 1/8	1/2	2 1/4	15/64	3/4	3/4-16	3 1/2	7 3/8	6 7/8

FAC

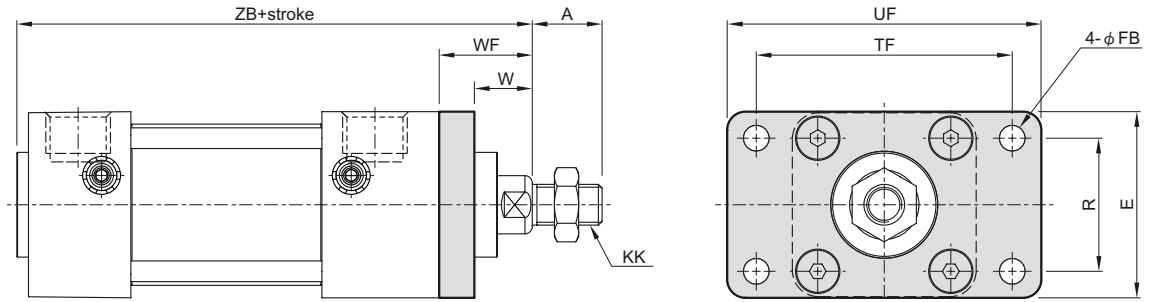

Code Tube I.D.	A	E	FB	KK	R	TF	UF	W	WF	ZB
1 1/2"	3/4	2	0.25	7/16-20	1.43	2.75	3.38	0.63	1	4 3/4
2"	3/4	2 1/2	0.31	7/16-20	1.84	3.38	4.13	0.63	1	4 3/4
2 1/2"	3/4	3	0.31	7/16-20	2.19	3.88	4.63	0.63	1	4 7/8
3 1/4"	1 1/8	3 3/4	0.38	3/4-16	2.76	4.68	5.50	0.75	1 3/8	5 53/64
4"	1 1/8	4 1/2	0.38	3/4-16	3.32	5.44	6.25	0.75	1 3/8	5 53/64

FBC

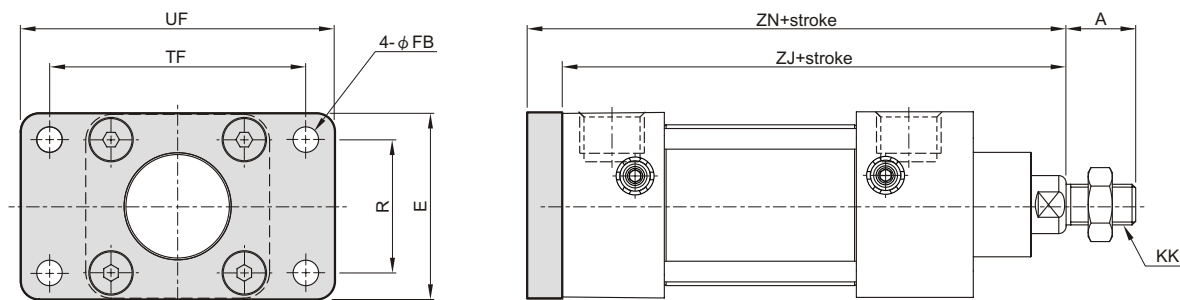

Code Tube I.D.	A	E	FB	KK	R	TF	UF	ZJ	ZN
1 1/2"	3/4	2	0.25	7/16-20	1.43	2.75	3.38	4.63	5.00
2"	3/4	2 1/2	0.31	7/16-20	1.84	3.38	4.13	4.63	5.00
2 1/2"	3/4	3	0.31	7/16-20	2.19	3.88	4.63	4.75	5.13
3 1/4"	1 1/8	3 3/4	0.38	3/4-16	2.76	4.68	5.50	5.63	6.25
4"	1 1/8	4 1/2	0.38	3/4-16	3.32	5.44	6.25	5.63	6.25

CB

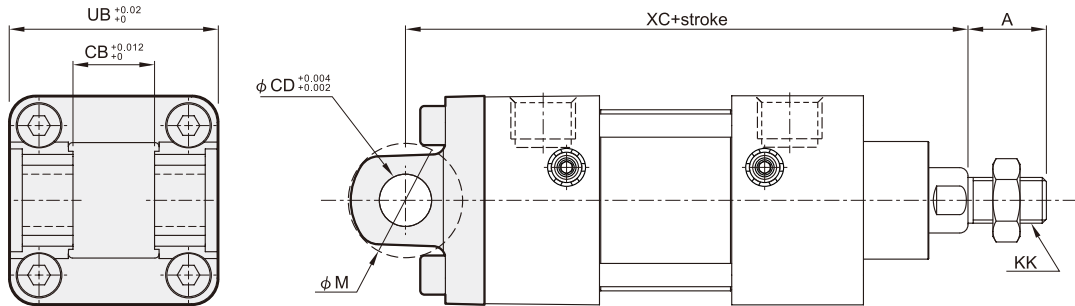

Code Tube I.D.	A	CB	CD	KK	M	UB	XC
1 1/2"	3/4	0.78	0.50	7/16-20	1.24	1.75	5.38
2"	3/4	0.78	0.50	7/16-20	1.24	1.75	5.38
2 1/2"	3/4	0.78	0.50	7/16-20	1.24	1.75	5.50
3 1/4"	1 1/8	1.28	0.75	3/4-16	1.88	2.50	6.88
4"	1 1/8	1.28	0.75	3/4-16	1.88	2.50	6.88

CB2

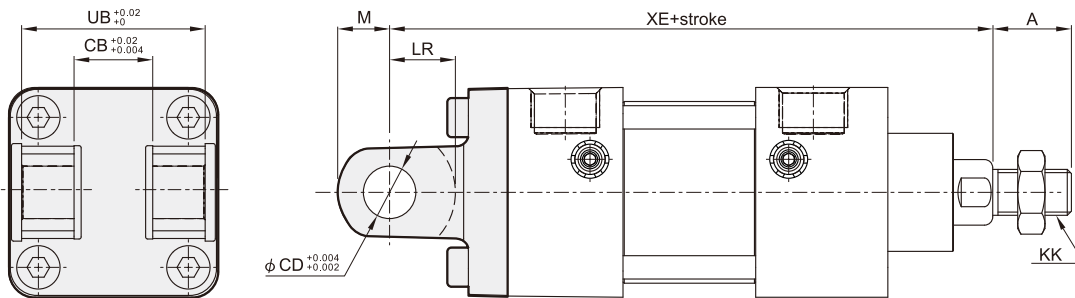

Code Tube I.D.	A	CB	CD	KK	LR	M	UB	XE
1 1/2"	3/4	0.75	0.50	7/16-20	5/8	0.5	1.75	5 3/4
2"	3/4	0.75	0.50	7/16-20	5/8	0.5	1.75	5 3/4
2 1/2"	3/4	0.75	0.50	7/16-20	5/8	0.5	1.75	5 7/8
3 1/4"	1 1/8	1.25	0.75	3/4-16	1	0.75	2.50	7 1/2
4"	1 1/8	1.25	0.75	3/4-16	1	0.75	2.50	7 1/2

TC

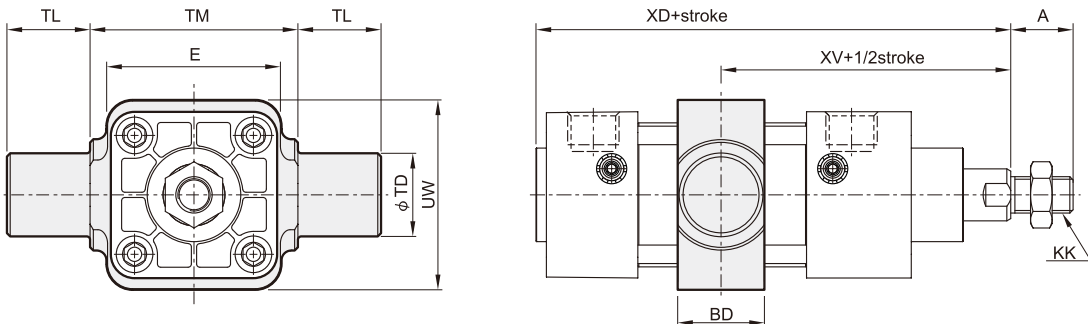

Code Tube I.D.	A	BD	E	KK	TD	TM	TL	UW	XD	XV
1 1/2"	3/4	1.04	2.11	7/16-20	1	2.50	1	2.28	4.94	3.20
2"	3/4	1.04	2.60	7/16-20	1	3.00	1	2.60	5.03	3.32
2 1/2"	3/4	1.10	3.09	7/16-20	1	3.50	1	3.23	5.07	3.33
3 1/4"	1 1/8	1.18	3.70	3/4-16	1	4.50	1	4.17	6.16	4.19
4"	1 1/8	1.22	4.49	3/4-16	1	5.25	1	4.96	6.18	4.19

STANDARD CYLINDERS

I connector

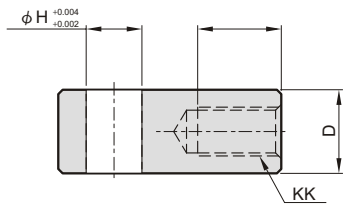
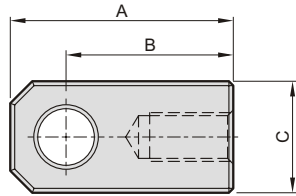

Code Tube I.D.	A	B	C	D	E	H	KK
1 1/2" ~ 2 1/2"	2.00	1.50	1.0	0.75	0.75	0.50	7/16-20
3 1/4" ~ 4"	2.81	2.06	1.5	1.25	1.13	0.75	3/4-16

Pin

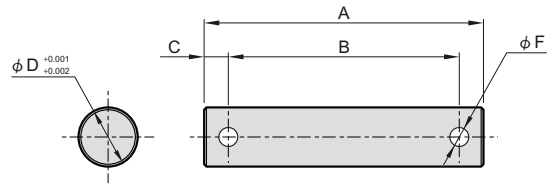

Code Tube I.D.	A	B	C	D	F
1 1/2" ~ 2 1/2"	2.36	1.95	0.20	0.50	0.16
3 1/4" ~ 4"	3.13	2.74	0.19	0.75	0.20

PIN-MCQN-1 1/2-I-P

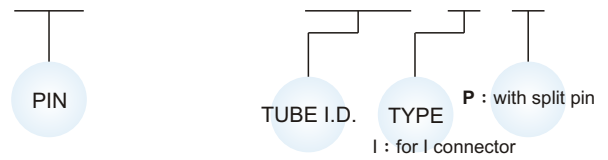

Y connector

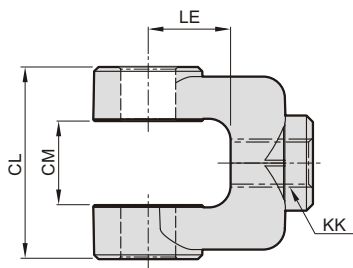
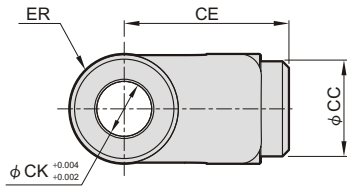

Code Tube I.D.	CC	CE	CL	CM	CK	ER	KK	LE
1 1/2" ~ 2 1/2"	0.87	1.50	1.75	0.765	0.50	0.50	7/16-20	0.75
3 1/4" ~ 4"	1.34	2.38	2.50	1.265	0.75	0.75	3/4-16	1.25