



08 - Cylinders

- Basic information
- Cylinder operation diagram
- Air consumption
- Axial load
- End of stroke damping properties
- Pull/Push force
- Single acting cylinders spring forces
- End cap screws - maximum torque

08

Base principles

- Function

Cylinders are, together with some other items, the components of an automatic system that transform the pneumatic energy in labour

$$L = F \times s$$

(Labour=Force x movement)

The theoretical force of a cylinder is directly proportional to the supply pressure and the surface upon which it acts (piston surface).

$$F = P \times S$$

(Force=Pressure x Surface)

(On the inwards stroke the area on which the pressure acts is reduced by the area of the piston rod)

The true force to the cylinder has to be calculated, bearing in mind :

- the friction of the seals during operation.
- the cylinder has to overcome the static friction generated by the seals before it can actually start moving. When a piston does not move for some time, the compression between the seals and barrel forces away the pre lubricating grease. When the cylinder is then operated it will therefore encounter a dry spot which will further increase breakaway friction.

Therefore, the real force is roughly 10 -15% lower than the theoretical force

Construction design

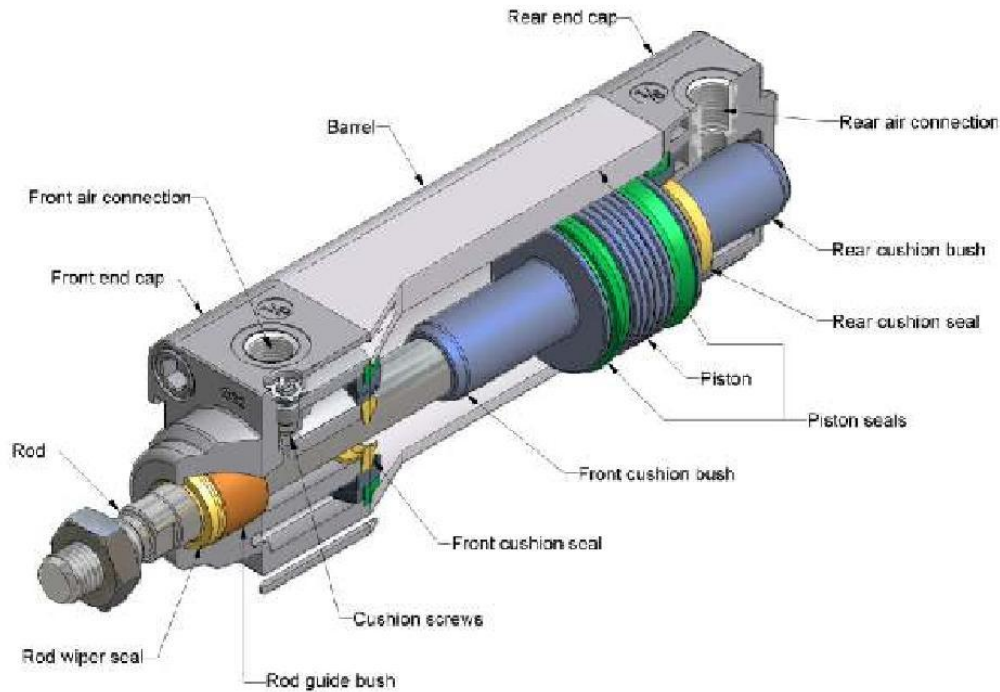

CYLINDER OPERATION DIAGRAM

A cylinder working cycle can be divided into 4 phases: start, acceleration, constant phase and cushioning.

Consider the diagram below showing a cylinder in rest position (piston rod IN) connected to a 5/2 valve (also in rest position (port 1 connected to port 2):

P_1 =atmospheric pressure P_2 =air line pressure (P_r)

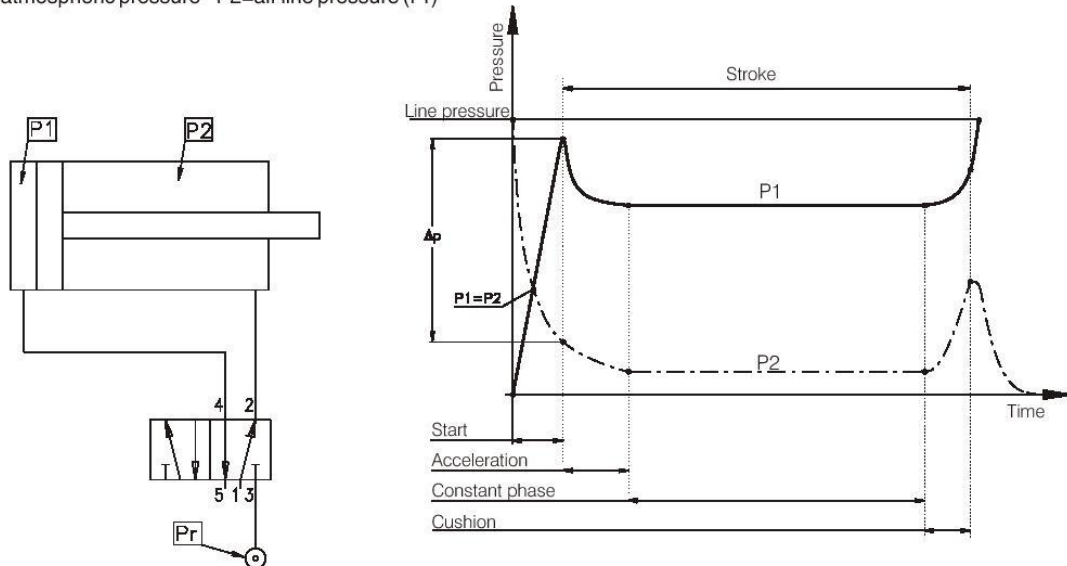

Start:

- actuating the 5/2 valve port 1 is connected to port 4 pressurizing the cylinder rear chamber ; in this conditions P_1 increases while the front chamber exhaust the pressure through port 3 (port 2 connected to port 3) and therefore P_2 decreases.

- theoretically when P_1 reaches the same value of P_2 the cylinder could start moving but in reality it still need to overcome friction and the load applied. When the Δp between the two pressures overcomes friction and load the cylinder will start moving

Acceleration:

The maximum speed is achieved at approximately 15 -30% of the unit stroke and is inversely proportional to the exhaust chamber volume and thereby the stroke; therefore considering units with the same bore the shorter the stroke the greater the acceleration will be.

Constant phase:

The translation speed is not always constant and is effected by many factors such as friction, load applied, mounting position, valve flow rate etc... The cylinder speed can be controlled by regulating the exhaust flow rate, always considering that it is important to use a valve with the highest possible flow rate (see section 09 "sizing and choosing a cylinder and valve) as the regulated speed would be lower than the maximum speed given by the valve.

Cushioning:

Is the final stage of the stroke when the front chamber exhaust flow is regulated. Under these conditions P_2 grows and counteracts P_1 reducing the unit speed until the end of stroke where P_1 reaches the maximum value given by the air supply and P_2 equals the atmospheric pressure.

CYLINDER AIR CONSUMPTION

The air consumption corresponds to the volume of air that the cylinder uses in a complete cycle (stroke out and back in) at a specific pressure.

$$\text{Consumption} = P_a \times C \times (A+b)$$

P_a= Absolute pressure (bar)
C= Cylinder stroke (dm)
A= see tab. 1 (dm²)
b= see tab. 2 (dm²)

Air consumption is measured in Normal-liters (NI) which correspond to the volume that a specific quantity (mass) of gas would fill at atmospheric pressure.

Calculation example:

ISO 15552 cylinder - 1319 series:
 Supply pressure 6 bar (P_a=7 bar)
 stroke 50mm (C=0,5 dm)
 Ø63 (A=0,31157 dm²)
 Rod Ø=20 mm (b=0,28017 dm²)

Consumption = 7 (bar) x 0,5 (dm) x (0,31157+0,28017) = **2,072 NI**

(In order to calculate the air consumption for a specific number of cycles it is sufficient to multiply the above value for the number of cycles)

Piston surface area		Surface difference Cylinder piston / rod Ø	
Ø cylinder	A	Ø cylinder - Ø rod	b
Ø 8	0,00502 dm ²	Ø 8 - Ø 4	0,00377 dm ²
Ø 10	0,00785 dm ²	Ø 10 - Ø 4	0,00659 dm ²
Ø 12	0,01130 dm ²	Ø 12 - Ø 6	0,00848 dm ²
Ø 16	0,02010 dm ²	Ø 16 - Ø 6	0,01727 dm ²
Ø 20	0,03140 dm ²	Ø 20 - Ø 8	0,02638 dm ²
Ø 25	0,04906 dm ²	Ø 25 - Ø 10	0,04121 dm ²
Ø 32	0,08038 dm ²	Ø 32 - Ø 12	0,06908 dm ²
Ø 40	0,12560 dm ²	Ø 40 - Ø 14	0,11021 dm ²
Ø 50	0,19625 dm ²	Ø 40 - Ø 16	0,10550 dm ²
Ø 63	0,31157 dm ²	Ø 40 - Ø 18	0,10017 dm ²
Ø 80	0,50240 dm ²	Ø 50 - Ø 14	0,18086 dm ²
Ø 100	0,78500 dm ²	Ø 50 - Ø 18	0,17082 dm ²
Ø 125	1,22656 dm ²	Ø 50 - Ø 20	0,16485 dm ²
Ø 160	2,00960 dm ²	Ø 63 - Ø 20	0,28017 dm ²
Ø 200	3,14000 dm ²	Ø 63 - Ø 22	0,27357 dm ²
		Ø 80 - Ø 22	0,46441 dm ²
		Ø 80 - Ø 25	0,45334 dm ²
		Ø 100 - Ø 25	0,73594 dm ²
		Ø 100 - Ø 30	0,71435 dm ²
		Ø 125 - Ø 30	1,15591 dm ²
		Ø 125 - Ø 32	1,14618 dm ²
		Ø 160 - Ø 40	1,88400 dm ²
		Ø 200 - Ø 40	3,01440 dm ²

tab.1

tab.2

Allowed axial load (combined bending and compressing load)

This is the maximum load that can be applied axially on the rod tip. Above this value the rod might bend under compression. This value depends on a number of factors such as load size, rod diameter, the distance at which the load is applied (bending and compressing length L) and the conditions under which the load is applied (cylinder mountings).

Among the possible conditions, the following three are the most common.

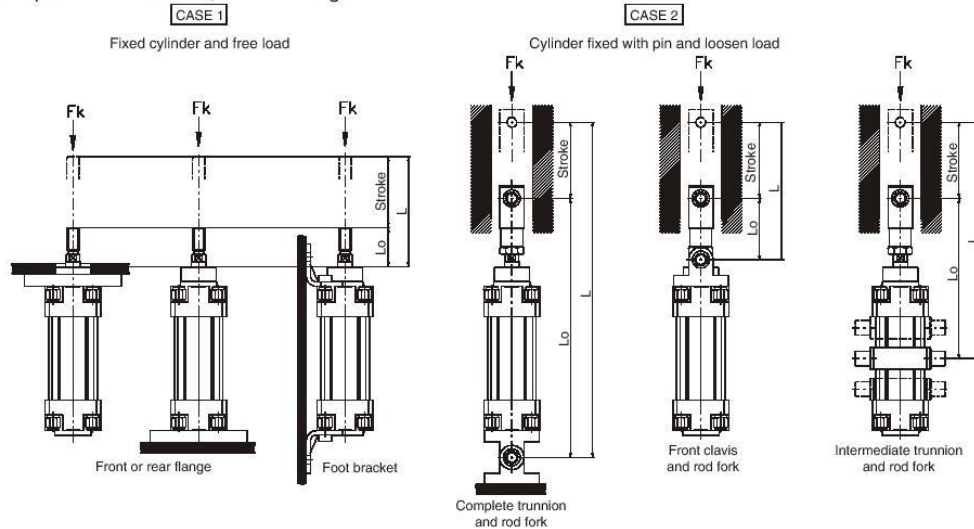

The maximum axial load can be calculated in two ways:

In an empirical way (see equations) or by checking the following diagram which shows the worst possible conditions (case 1 & 2) For all other possible mountings alternatives the axial load will surely be higher.

$$F_k = \frac{\pi^3 \times E \times d^4}{64 \times L^2 \times C} \quad (N)$$

$$d = \sqrt[4]{\frac{F_k \times 64 \times L^2 \times C}{\pi^3 \times E}} \quad (cm)$$

$$L = \sqrt[4]{\frac{\pi^3 \times E \times d^4}{F_k \times 64 \times C}} \quad (cm)$$

Example: Axial load verification

Cylinder ø80 mm
 Rod diameter ø20 mm
 Stroke 600 mm
 Mounting CASE 2 intermediate trunnion: L0=290 mm
 Carico 2000 N
 L (distance)= 29+60=89 cm
 $F_k = (\pi^3 \times 2,1 \times 10^7 \times 2^4) : (64 \times 89^2 \times 5) = 4104$ N
 (Above the 2000 N applied)

The same result can be obtained using the below diagram: following the bending and compression distance line relative to 900mm up to the intersection with the 20mm Ø line we obtain 4000N.

Example: rod diameter sizing

E= rod material coefficient of elasticity (N/cm²)
 (steel=2,1x10⁷ N/cm²)

d= rod diameter (cm)

L= bending and compression distance (cm)

C= safety factor (da 2,5 a 5)

Considering the same conditions as in the above case we need to determinate the rod diameter suitable to withstand a 4000N load

$$d = \sqrt[4]{(4000 \times 64 \times 89^2 \times 5) / (\pi^3 \times 2,1 \times 10^7)} = 2 \text{ cm}$$

The diameter to choose is the next one up : Ø25 mm

Also this second example can be resolved using the below diagram: following the bending and compression distance line relative to 900mm up to the intersection with the 4000N maximum load we obtain Ø20 mm.

With the third equation or using the diagram it is possible to calculate the bending and compression distance.

Axial load diagram

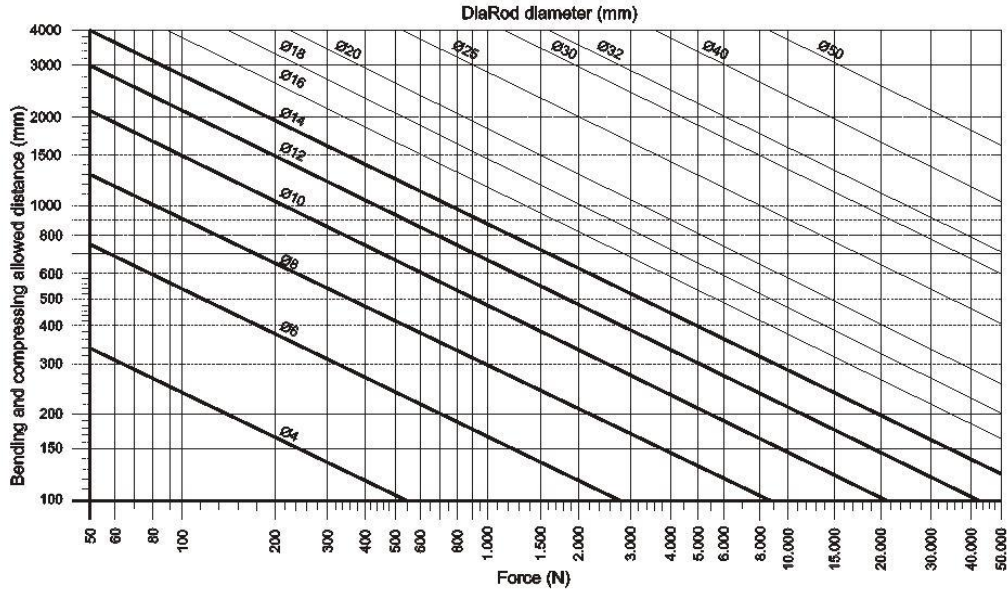

END OF STROKE CUSHIONING CAPABILITY

The function of the end of stroke cushioning is to reduce the kinetic energy generated by movement of the load and to prevent high speed impact between the piston and end caps that could compromise the unit functionality. The use of non-cushioned cylinders is not recommended on high speed applications unless external means of deceleration (such as dampers) are used.

The maximum load that can be cushioned depends on the speed of the unit and the cylinder cushioning capacity. The chart below shows the values relative to the ISO 15552 series cylinders considering the out stroke movement and a supply pressure of 6 bar. The acceptable values for any diameter are those found below each size line.

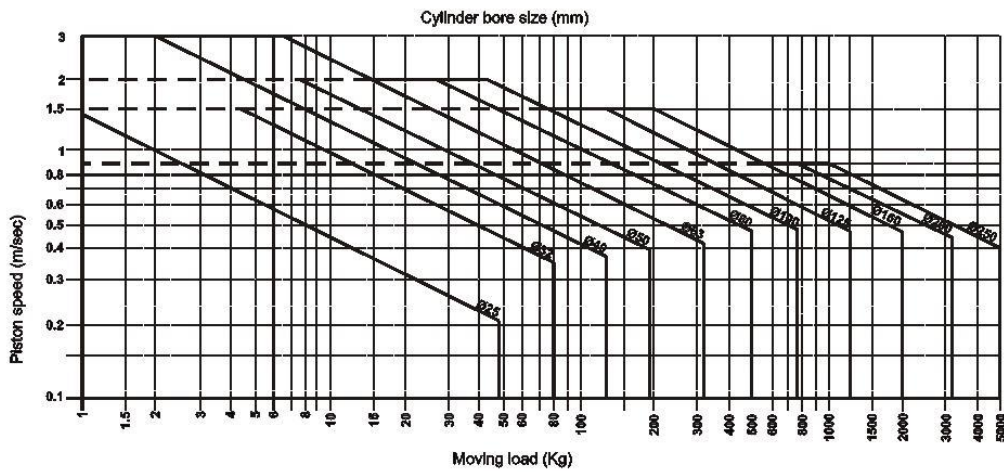

08





THEORETICAL FORCE -PUSH- (N) - rod moving out

Bore (mm)	Push area (mm ²)	Feeding pressure (bar)									
		1	2	3	4	5	6	7	8	9	10
Ø6	28	2.5	5.5	8	11	13.5	16.5	19	22	24.5	27.5
Ø8	50	4.5	9.5	14.5	19.5	24.5	29.5	34	39	44	49
Ø10	79	7.5	15	23	30.5	38	46	53.5	61.5	69	76.5
Ø12	113	11	22	33	44	55	66	77	88	99	110
Ø16	201	19	39	58	78	98	118	137	157	177	197
Ø20	314	30	61	92	123	153	184	215	246	277	307
Ø25	491	48	96	144	192	240	288	336	384	432	481
Ø32	804	76	152	228	315	394	472	551	630	708	788
Ø40	1,256	123	246	369	492	615	739	862	985	1,109	1,231
Ø50	1,963	192	384	577	769	962	1,154	1,347	1,539	1,732	1,924
Ø63	3,118	306	611	916	1,222	1,527	1,833	2,138	2,444	2,749	3,056
Ø80	5,024	492	985	1,478	1,970	2,463	2,956	3,448	3,941	4,434	4,926
Ø100	7,850	769	1,539	2,309	3,079	3,849	4,618	5,388	6,158	6,928	7,698
Ø125	12,266	1,202	2,405	3,608	4,811	6,014	7,217	8,419	9,622	10,825	12,028
Ø160	20,196	1,970	3,941	5,912	7,884	9,855	11,826	13,796	15,766	17,736	19,707
Ø200	31,400	3,079	6,158	9,237	12,317	15,396	18,475	21,555	24,634	27,713	30,792
Ø250	49,088	4,811	9,622	14,434	19,245	24,056	28,868	33,679	38,491	43,302	48,113





The following equations is used to calculate the force generated in the return stroke (rod moving back in) :
F=(Cylinder area - Rod area) x Pressure (area in cm² and pressure in bar)

In order to obtain the cylinder real force, reduce the theoretical value by 10-15%





SINGLE ACTING CYLINDER SPRING INITIAL AND FINAL LOAD CHARACTERISTICS.

Microcylinders ISO 6431 - 1260 series			Bore						
	front spring	rear spring	Ø12	Ø16	Ø20	Ø25	Ø32	Ø40	Ø50
Initial load (N) external spring			9,9	10,8	10,8	7,9	19,7	39,3	39,3
Final load (N) compressed load			26,5	22,6	22,6	49,1	53,0	106,0	106,0





(stroke 0-40 mm)

Microcylinders ISO 6431 - 1280 series "MIR"			Bore						
	front spring	rear spring	Ø8	Ø10	Ø12	Ø16	Ø20	Ø25	Ø32
Initial load (N) external spring			2,2	2,2	4,0	7,5	11,0	16,5	23,0
Final load (N) compressed load			4,2	4,2	8,7	21,0	22,0	30,7	52,5





(stroke 0-50 mm)

Cylinders ISO 15552 - 1319-20-21 series			Bore					
	front spring	rear spring	Ø32	Ø40	Ø50	Ø63	Ø80	Ø100
Initial load (N) external spring			17,2	24,6	51,0	51,0	98,1	98,1
Final load (N) compressed load			41,7	83,4	114,8	114,8	194,2	194,2

(stroke 0-50 mm)

Short stroke compact cylinders			Bore							
	front spring	rear spring	Ø20	Ø25	Ø32	Ø40	Ø50	Ø63	Ø80	Ø100
Initial load (N) external spring			7,9	9,9	34,4	34,4	50,1	54,0	117,7	108,9
Final load (N) compressed load			27,5	26,5	59,9	63,8	79,5	85,4	157,0	134,4

(stroke 0-10 mm)

"Europe" Compact cylinders			Bore									
	front spring	rear spring	Ø12	Ø16	Ø20	Ø25	Ø32	Ø40	Ø50	Ø63	Ø80	Ø100
Initial load (N) external spring			3,9	4,4	4,9	9,8	12,3	16,7	27,5	37,3	59,4	101,3
Final load (N) compressed load			9,3	17,7	18,1	25,5	34,3	44,1	51,0	63,8	99,4	141,9

CYLINDER NUTS RECOMMENDED TIGHTENING TORQUE

Bore size	Coppia (Nm)
Ø32	8
Ø40	8
Ø50	16
Ø63	16
Ø80	22
Ø100	22
Ø125	30
Ø160	85
Ø200	85