

MAF403 series

AIR UNITS (Filter)



mindman



Symbol

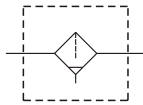

Specification

Model	MAF403		
Bore No.	8A	10A	15A
Port size	1/4	3/8	1/2
Medium	Air		
Operating pressure range (※)	0.05~1 MPa		
Proof pressure	1.5 MPa		
Ambient temperature	-5~+60°C (No freezing)		
Filter element	Standard: 40 μm Option: 5 μm		
Weight	345 g		

※ 1. Standard unit contains semi-auto-drain function when operating pressure below 0.05 MPa.

※ 2. Choose auto-drain FMRF300, the pressure range is 0.15 ~ 1 MPa.

Order example

MAF403 - 8A - D - □ - B - □

MODEL

BORE SIZE

8A: 1/4
10A: 3/8
15A: 1/2

D: Auto drain valve (FMRF300)
N: Nylon bowl

FILTER ELEMENT

Blank: 40 μm
5u: 5 μm

B: C type bracket

PORT THREAD
Blank: Rc thread
G: G thread
NPT: NPT thread

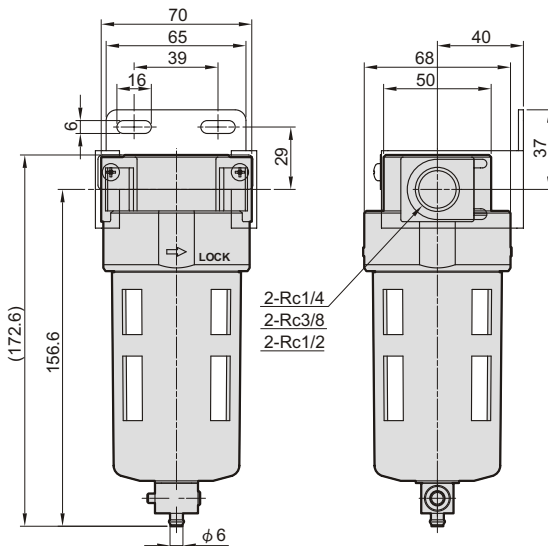
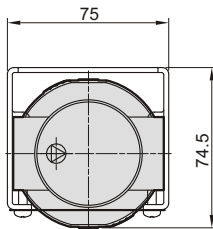
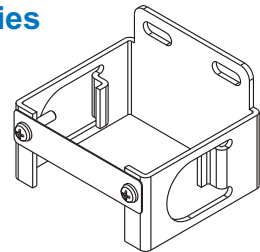

Option accessories

C type bracket

Flow feature

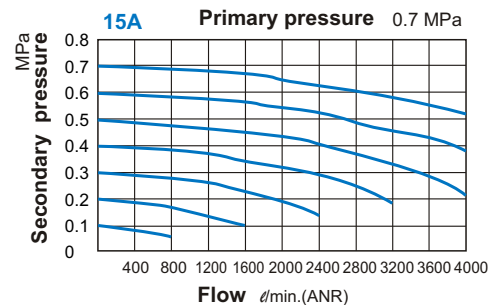
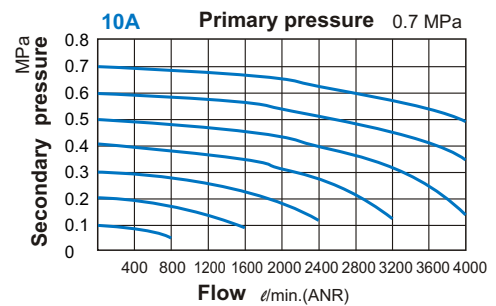
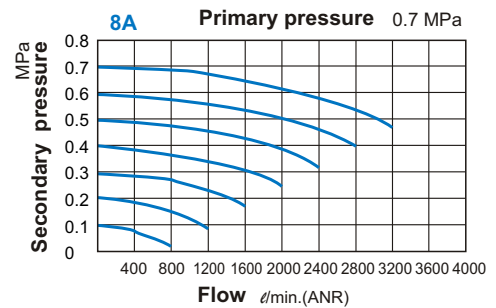

mindman